

INSTALLATION MANUAL

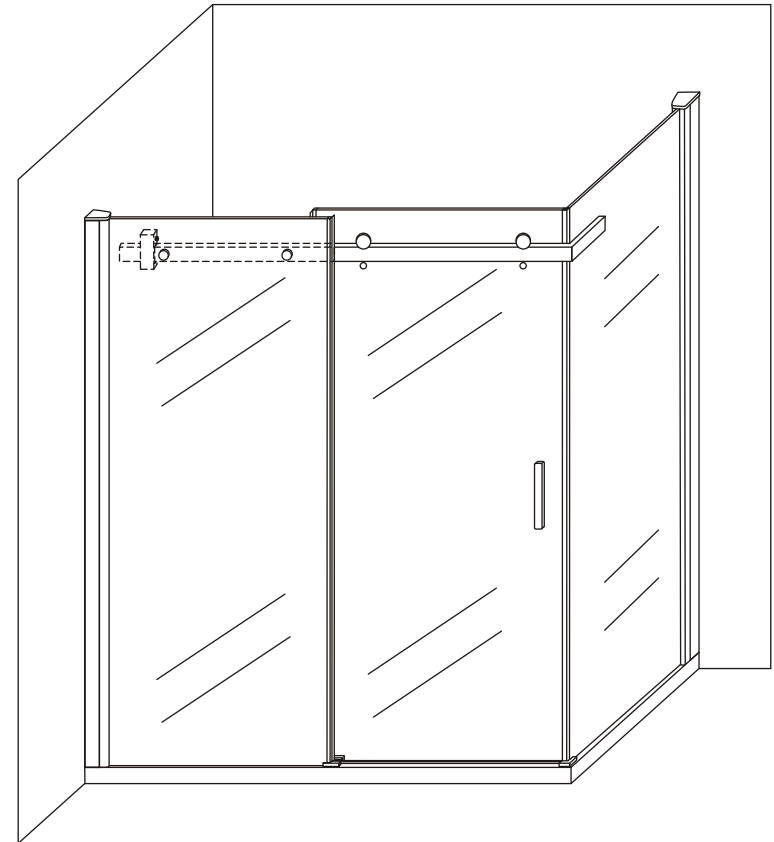

BL-045F

RoHS **CE** ISO9001:2000

TOOL PICTURE

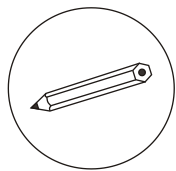

Pencil

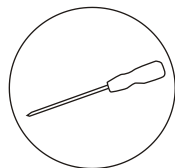

Cross screw driver

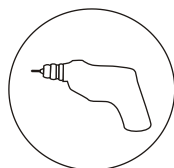

Drill machine (6mm)

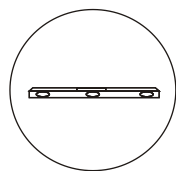

Level ruler

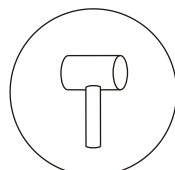

Rubber hammer

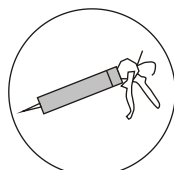

Silicon gel

Accessory list



Side cover

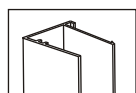

Wall profile

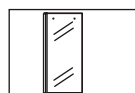

Glass

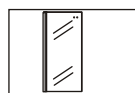

Glass

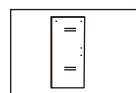

Glass

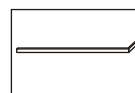

Rail bar

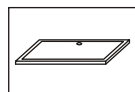

Tray

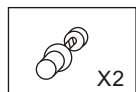

PJ-4419

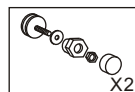

LZ-5012

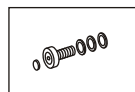

Screw



CT-8DST90

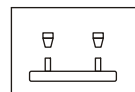

LS-1009

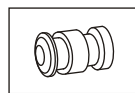

PJ-4038

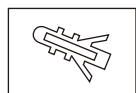

Expand tube

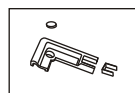

PJ-4147/
PJ-4148

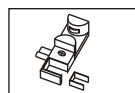

PJ-4131

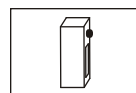

PJ-4012

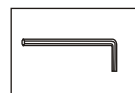

PJ-4026

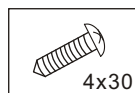

Screw
4x30

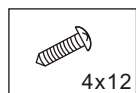

Screw
4x12

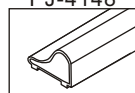

Aluminum
bottom bar



CT-8BMX90

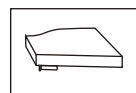

PJ-4514/
PJ-4515

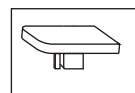

PJ-4509

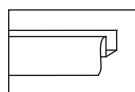

8S-180

1. Fix the side rubber water proof strip on the fixed glass and the door glass.
2. Install the megatic gasket between the door glass and the fixed glass.
3. Make holes on the aluminum profile and tighten the screws, then install the decorative aluminum part.
4. Install the decoration cap onto the wall profiles.
5. Install the handle.
6. Add some silicone along the fixed glass.
7. Move the door glass to the same direction with the fixed glass to a proper position and fix rightly the metal part with hexagon, see detail photos.

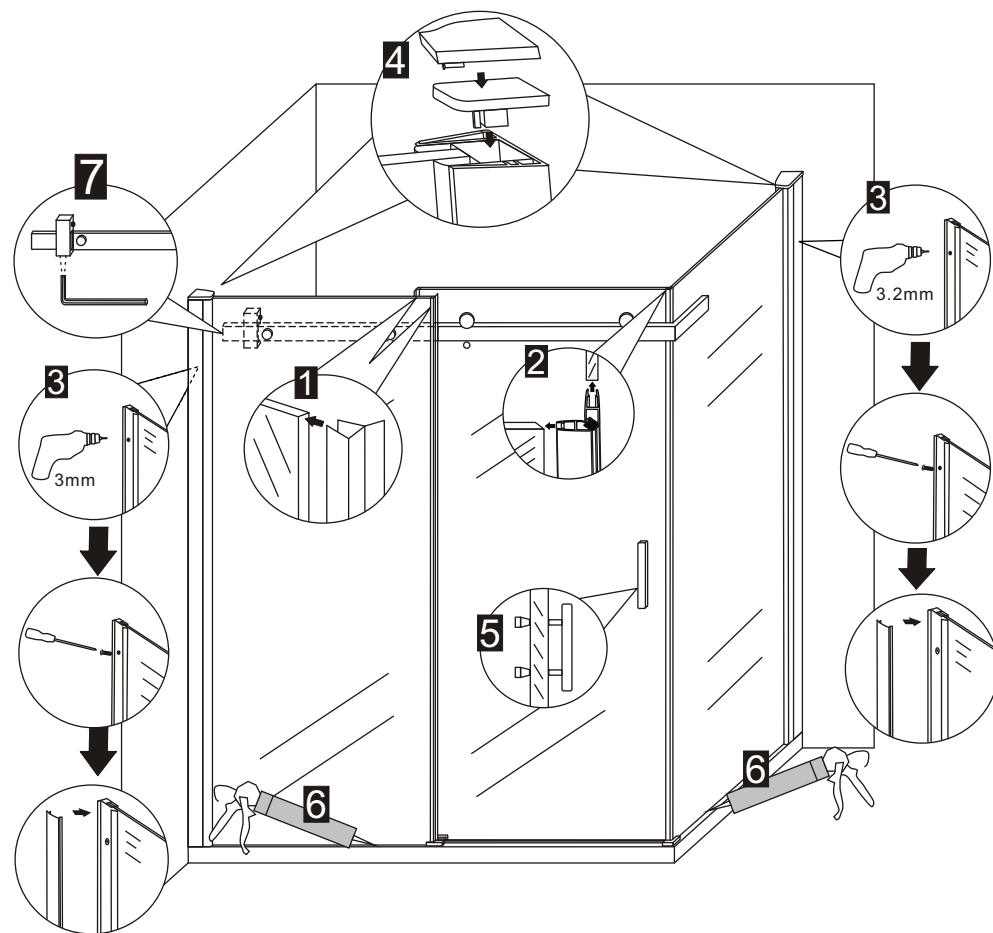
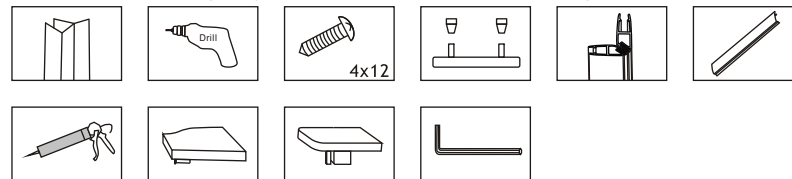

1. Hang the door glass onto the rail and keep the bottom part of the door glass into the bottom rectangle metal part .
2. Install the small glass holder and fasten it onto the glass. Pls note you must adjust well the roller to make sure the small glass holder match close to rail at about 0.5-1mm to prevent the glass fall down or coming out .

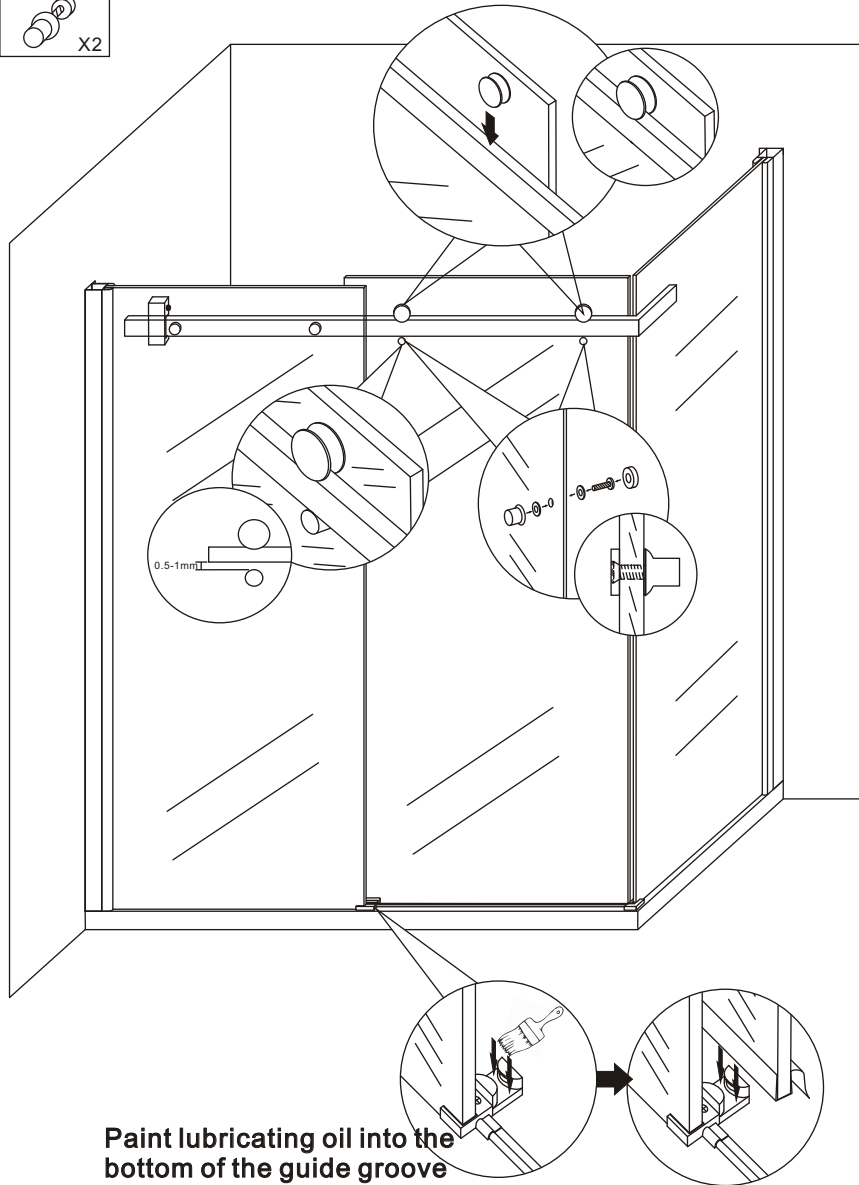
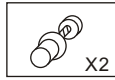

Paint lubricating oil into the bottom of the guide groove

Put the tray on the floor and make sure it is level with a level ruler .

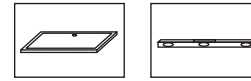

DO NOT PUT THE SHOWER TRAY TOO MUCH INTO THE WALL TILE , OTHERWISE ,THE TRAY SIZE WILL BE NOT MATCH WITH THE SHOWER !

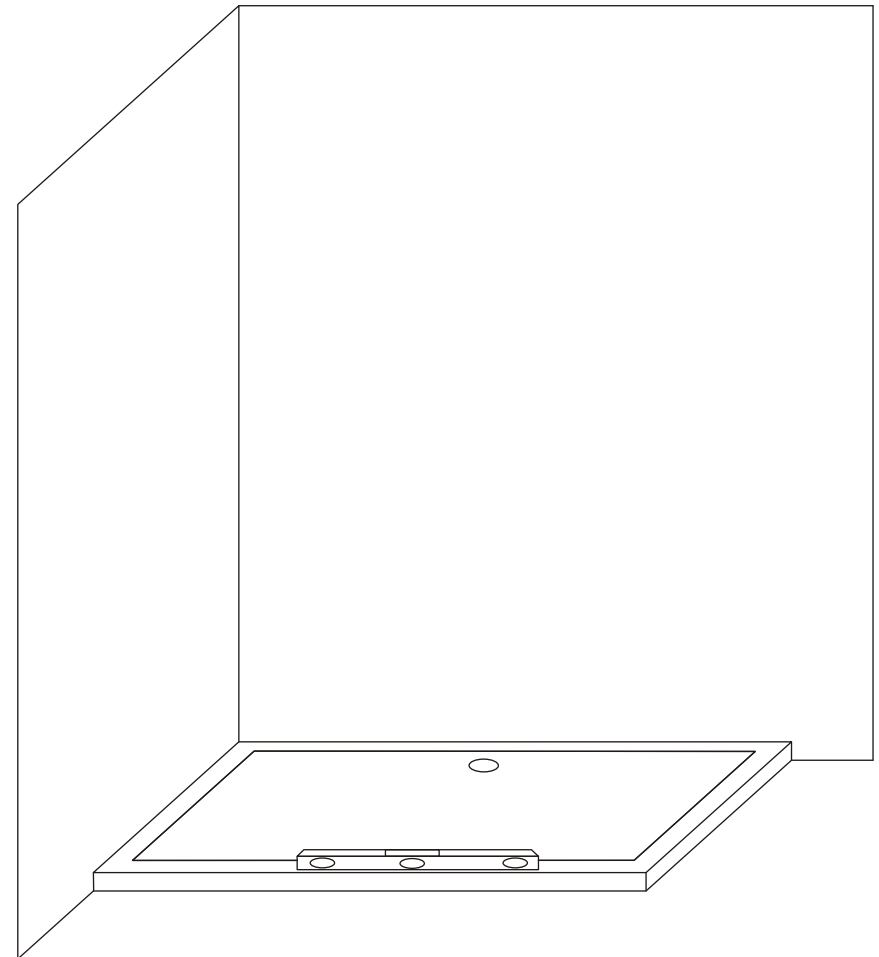

1. Use pencil and ruler draw the vertical installation line

shower enclosure size	The installation size L1	The installation size L2
1000X800	775	975
1200X800	775	1175
1200X900	875	1175

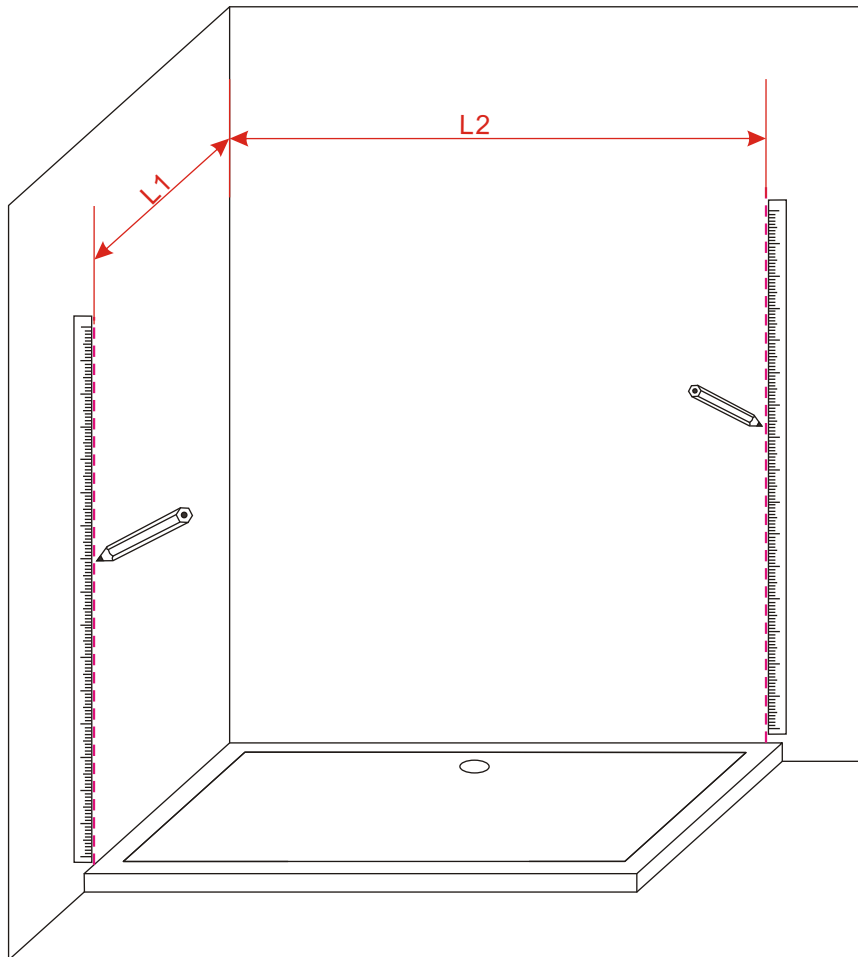

3

1. Install the rollers on the door glass and fix them tightly.

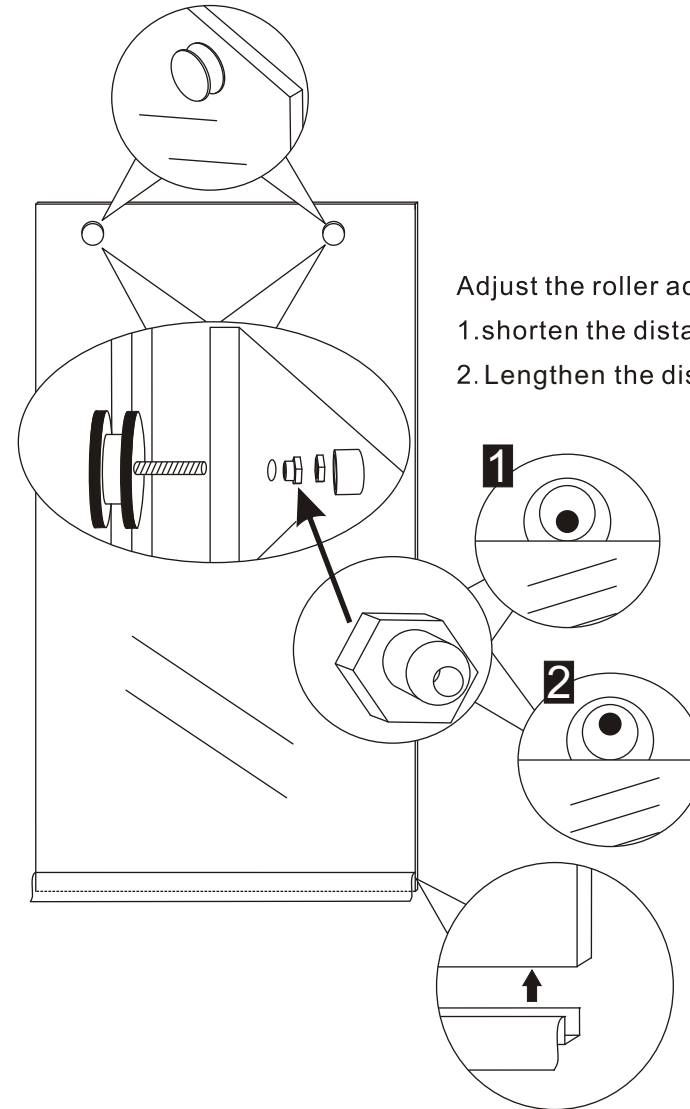
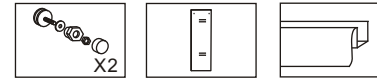

Adjust the roller accordingly:

1. shorten the distance of glass and the rail.
2. Lengthen the distance of the glass and rail.

8

1. Insert the rectangle metal part into the fixed glass , make sure the position and make the glass silica gel , Install the decorative pieces (as the picture show) .

2. Install the water-proof aluminum profile with silicone.

3. Insert the 90°water-proof aluminum profile into the fixed glass and make the glass silica gel.

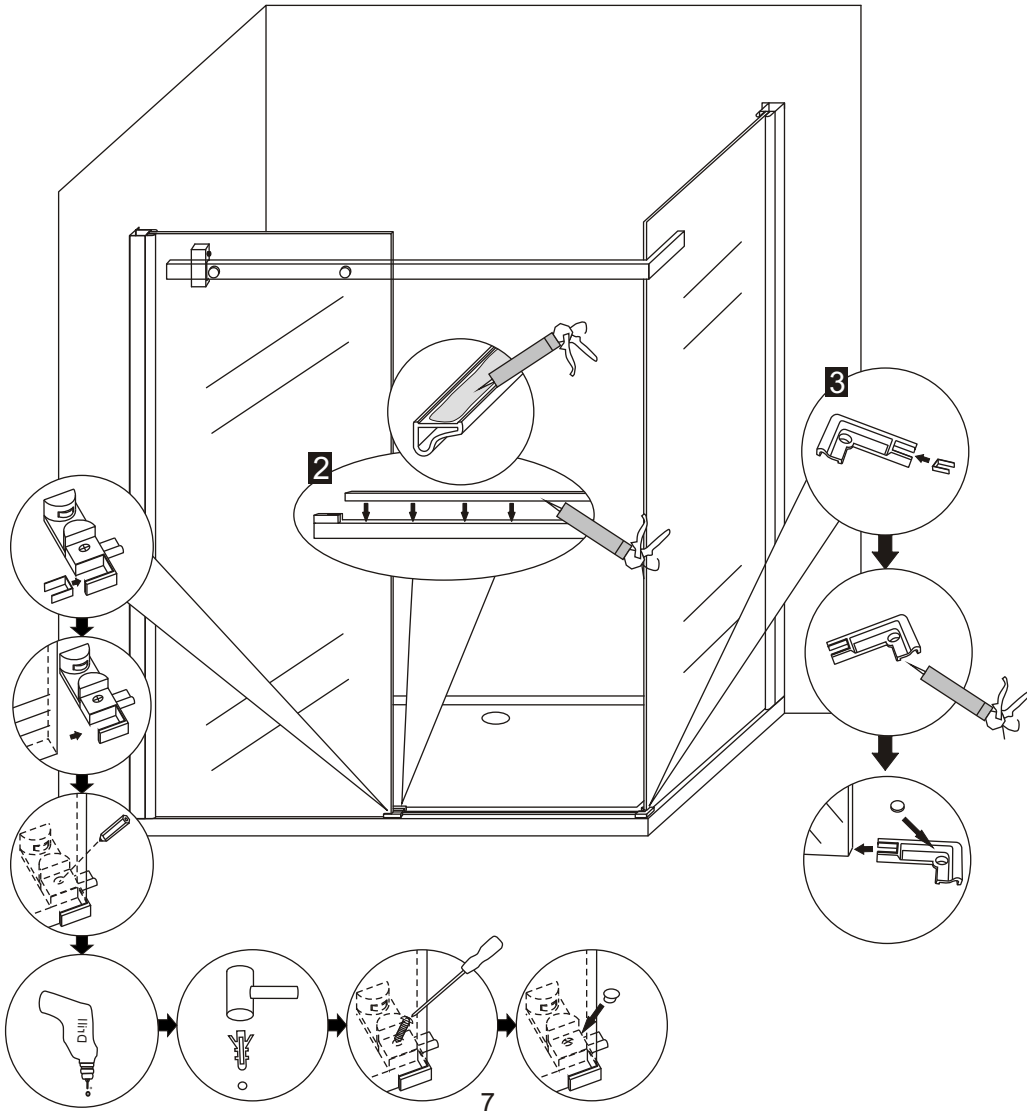
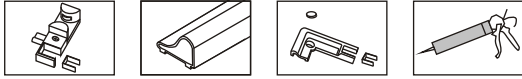

1. aluminum profile, the wall aluminum profile should be in the same plane with the tray of the edge.

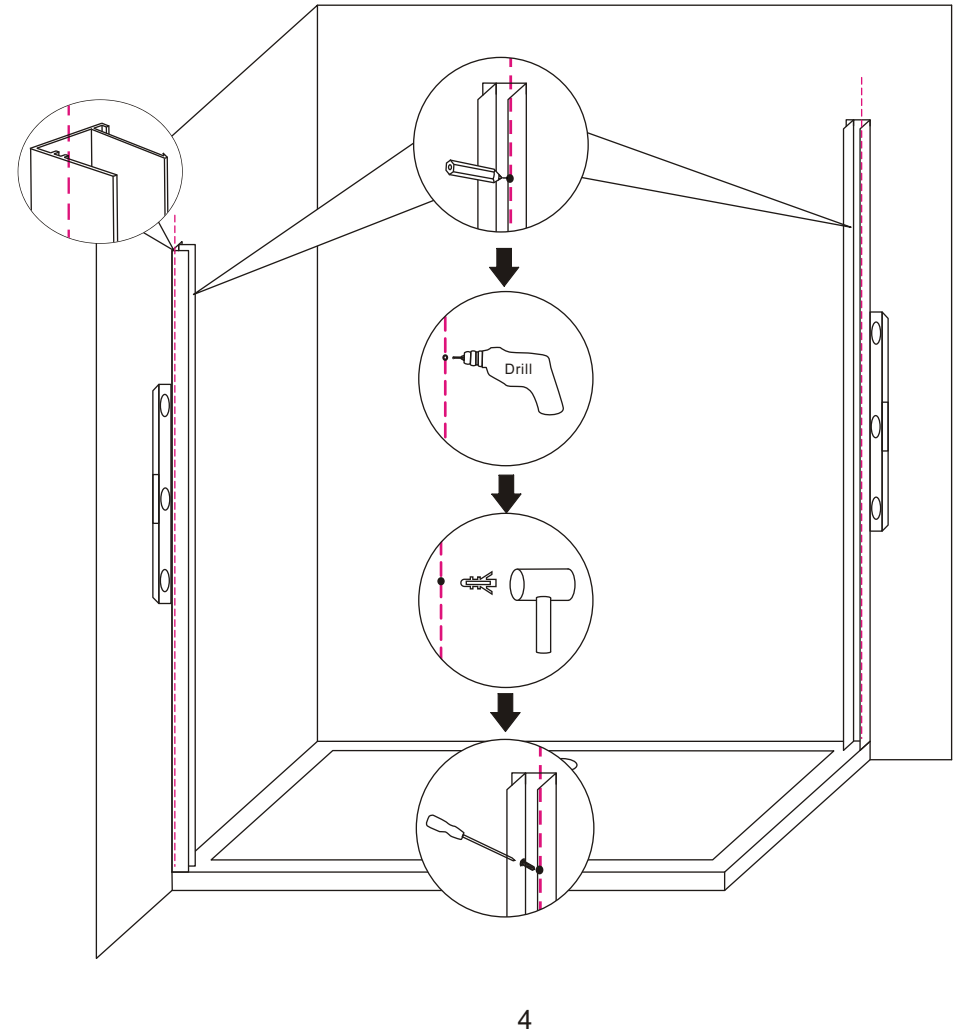
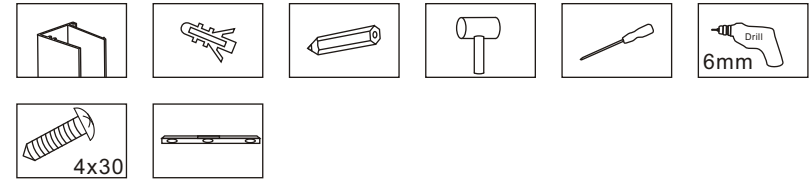

1. Insert the two fixed glasses into the wall aluminum profile.

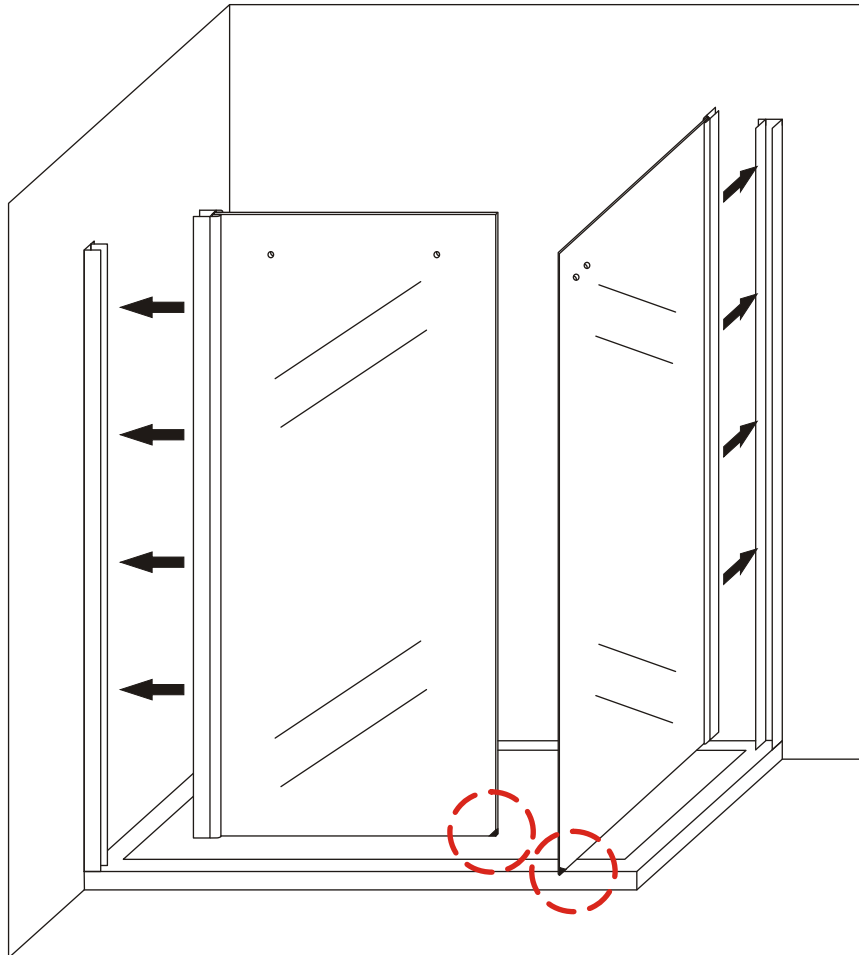
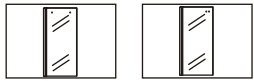

Attention: Do not remove the Black corner protector until insert well the glass into the wall profiles and fit well to prevent glass broken and splitted.



1. Put the stop block into the sliding guide rails.
2. Install the sliding guide rails according the glass holes.
3. Install the connector between the fixed door and sliding guide rails , use Use inner hexagon spanner to fixed.

